

Rackarm 35 mm

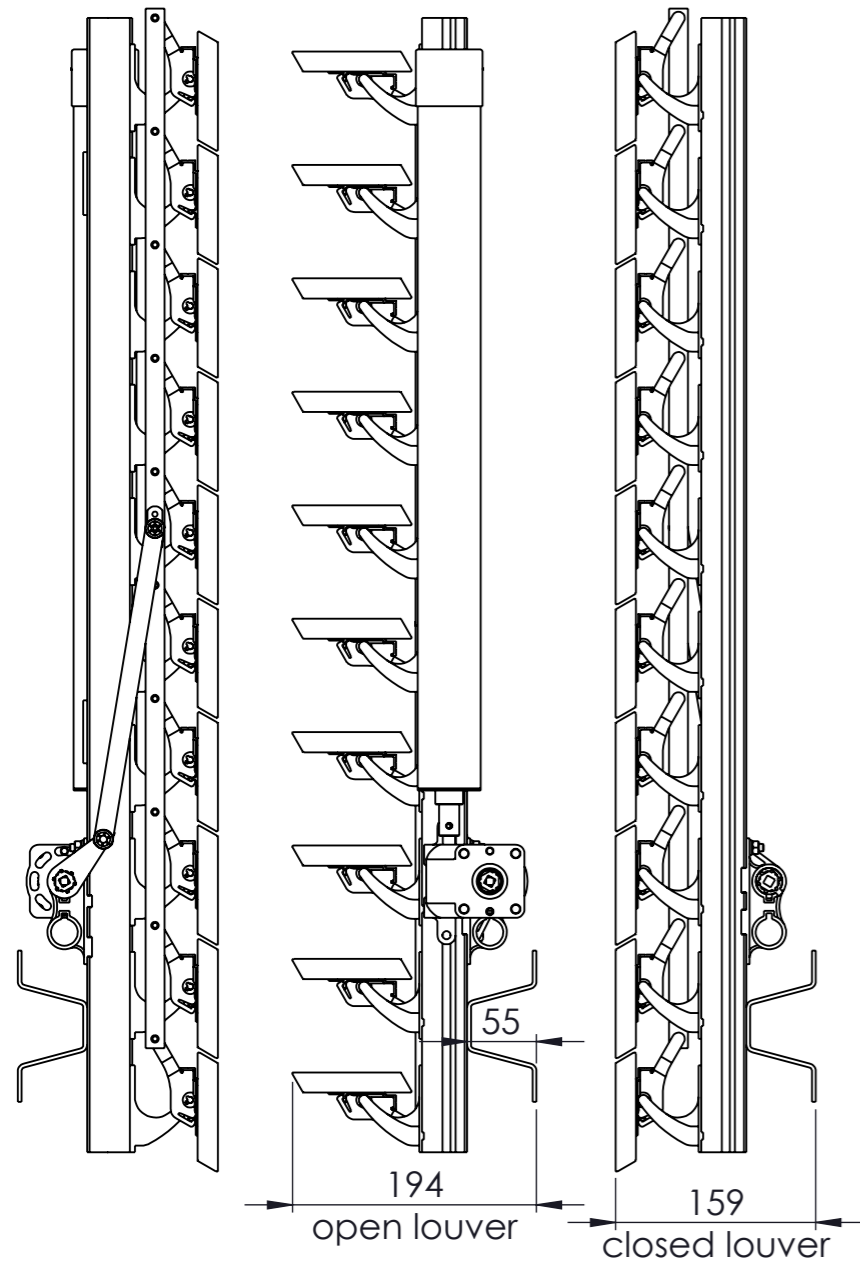

Rackarm 80 mm

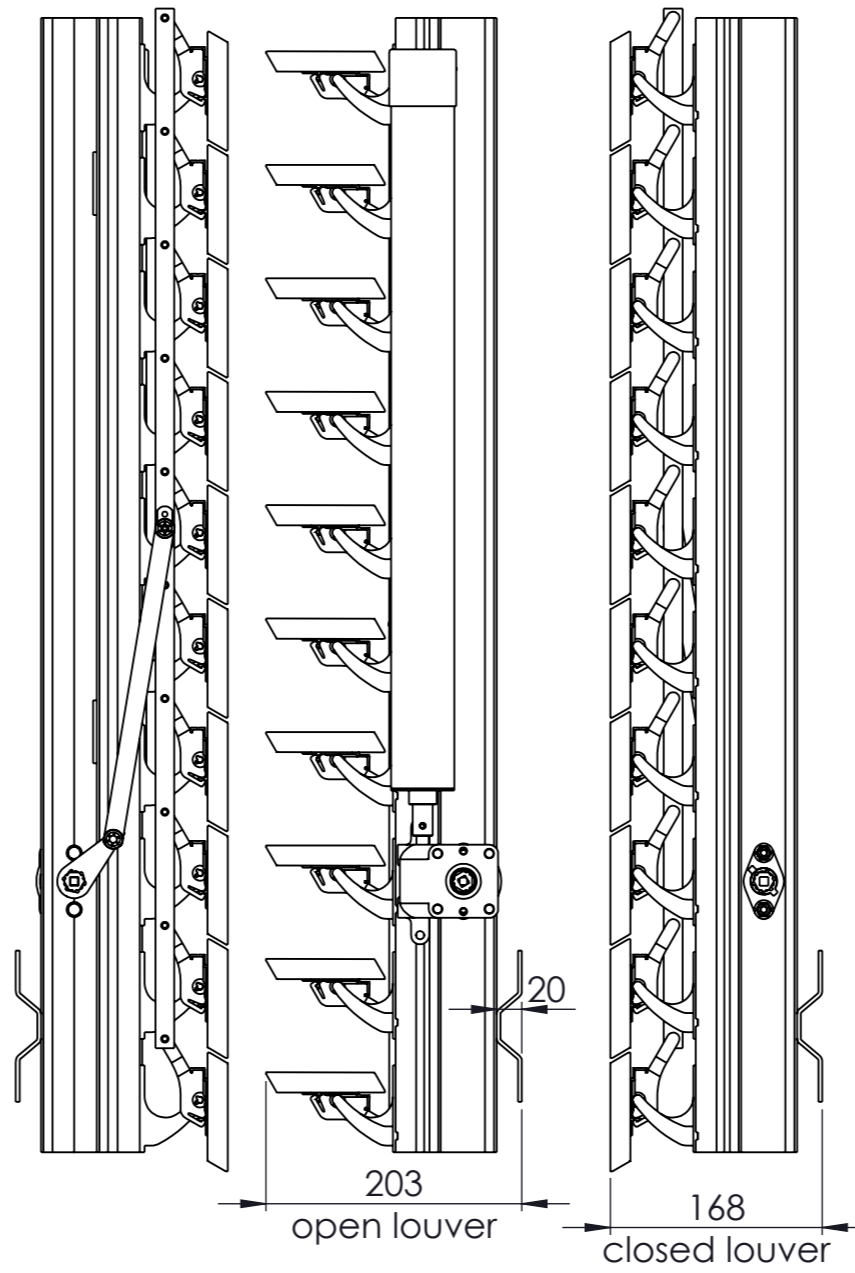

Rackarm 98 mm

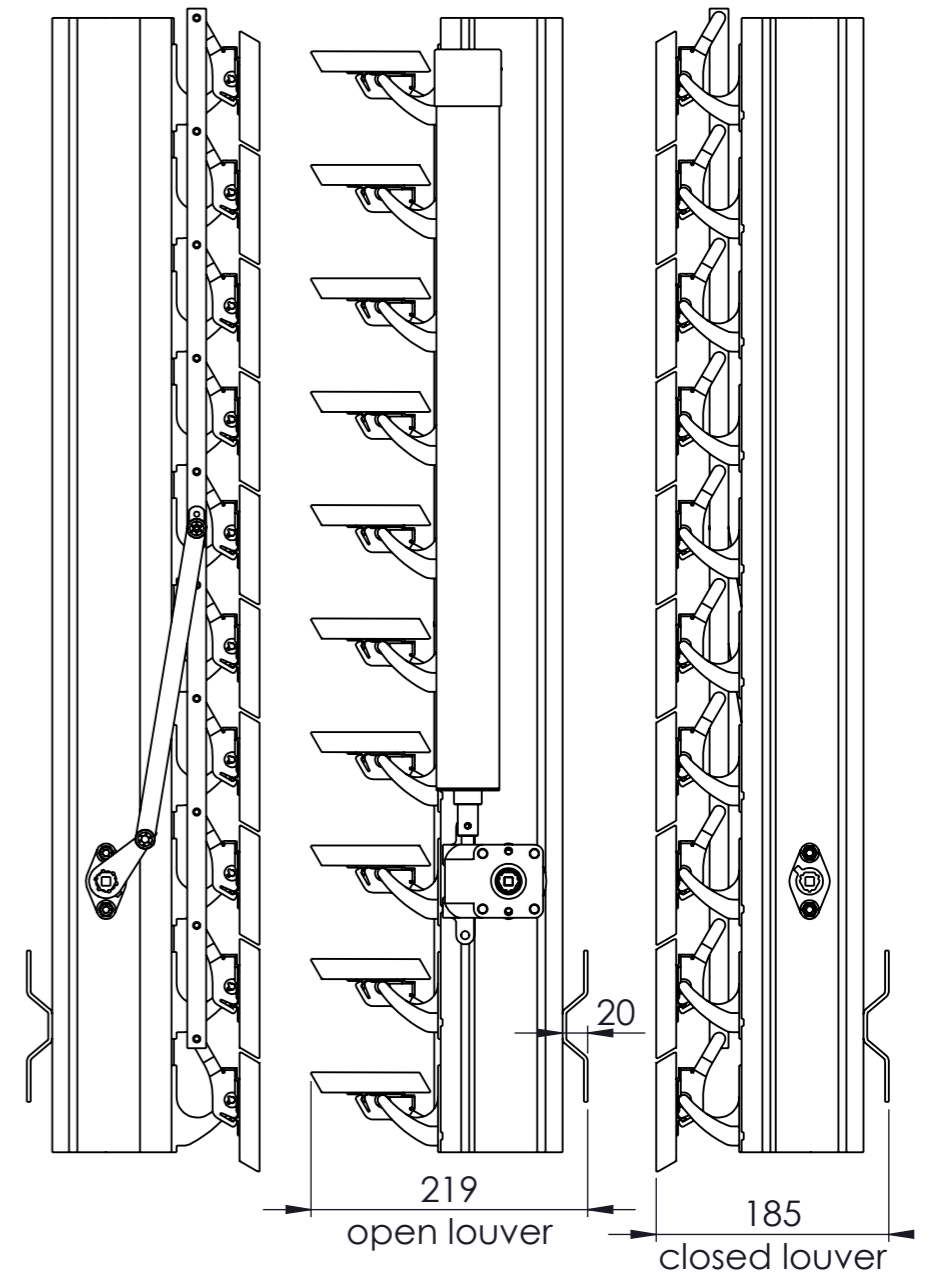

* Additional heavy duty Rack Arm extrusion options are available. Please contact Horiso for more information.

87W scale 1:6

horiso®

E: info@horiso.com.au | T: +61 2 8755 4500

horiso.com.au