

Rackarm 35 mm

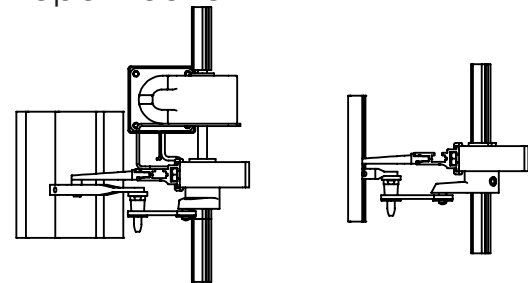

Rackarm 80 mm

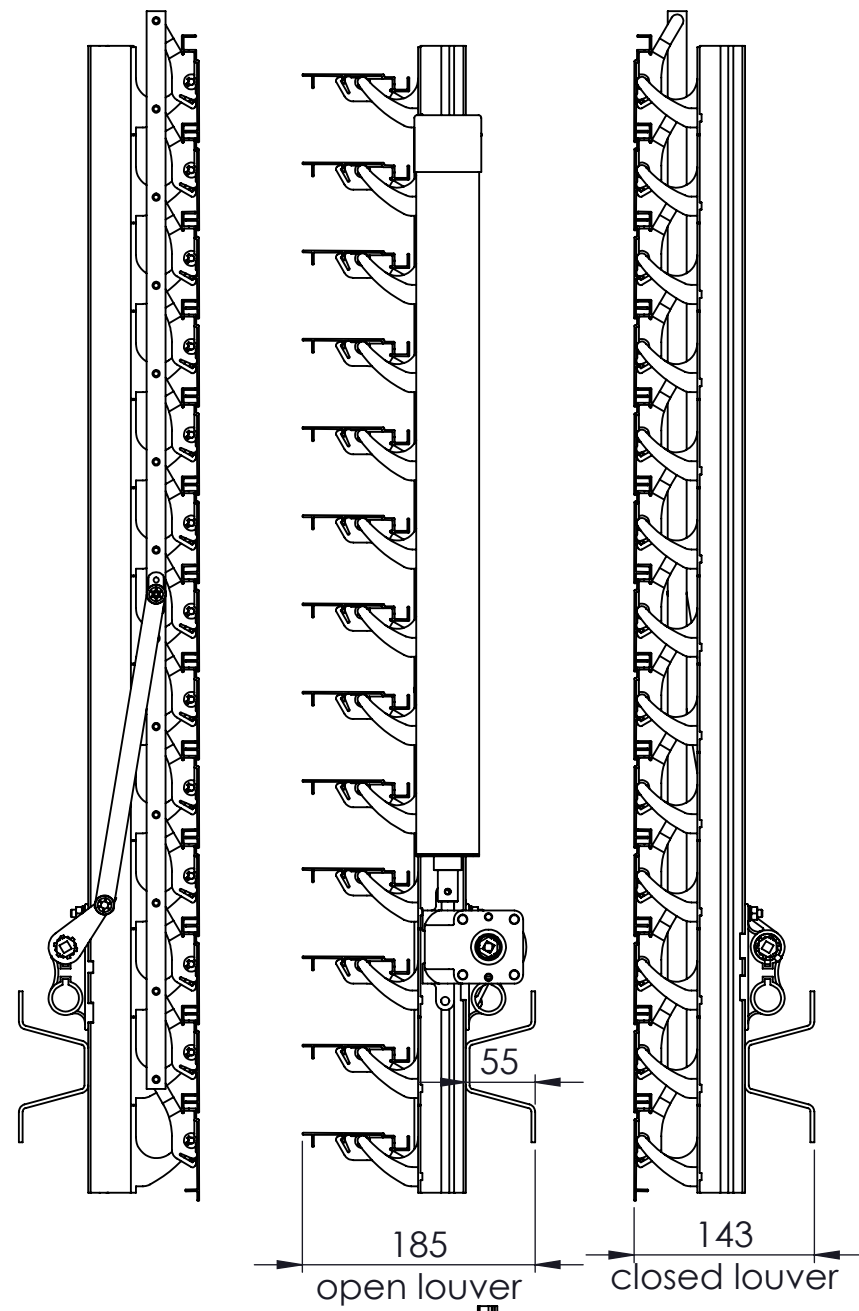
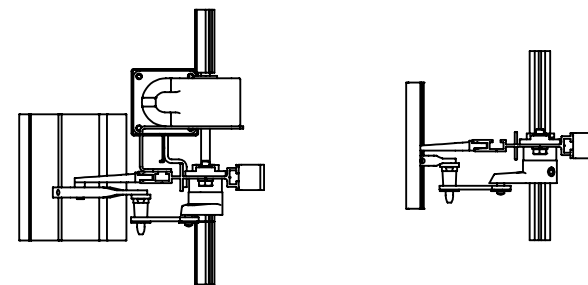
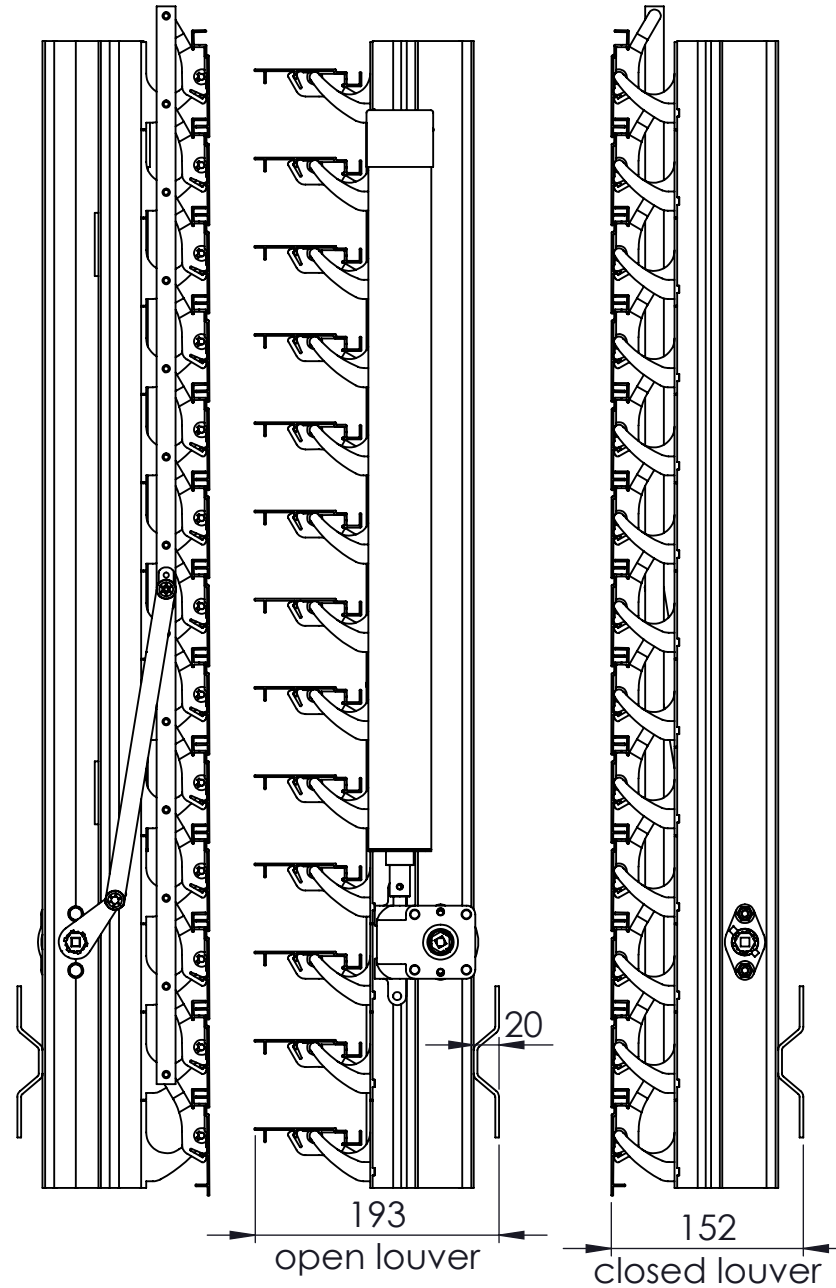

Rackarm 98 mm

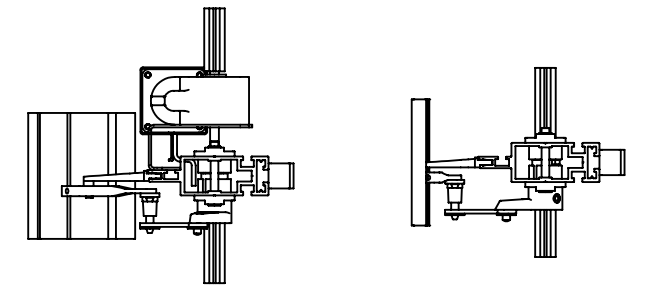
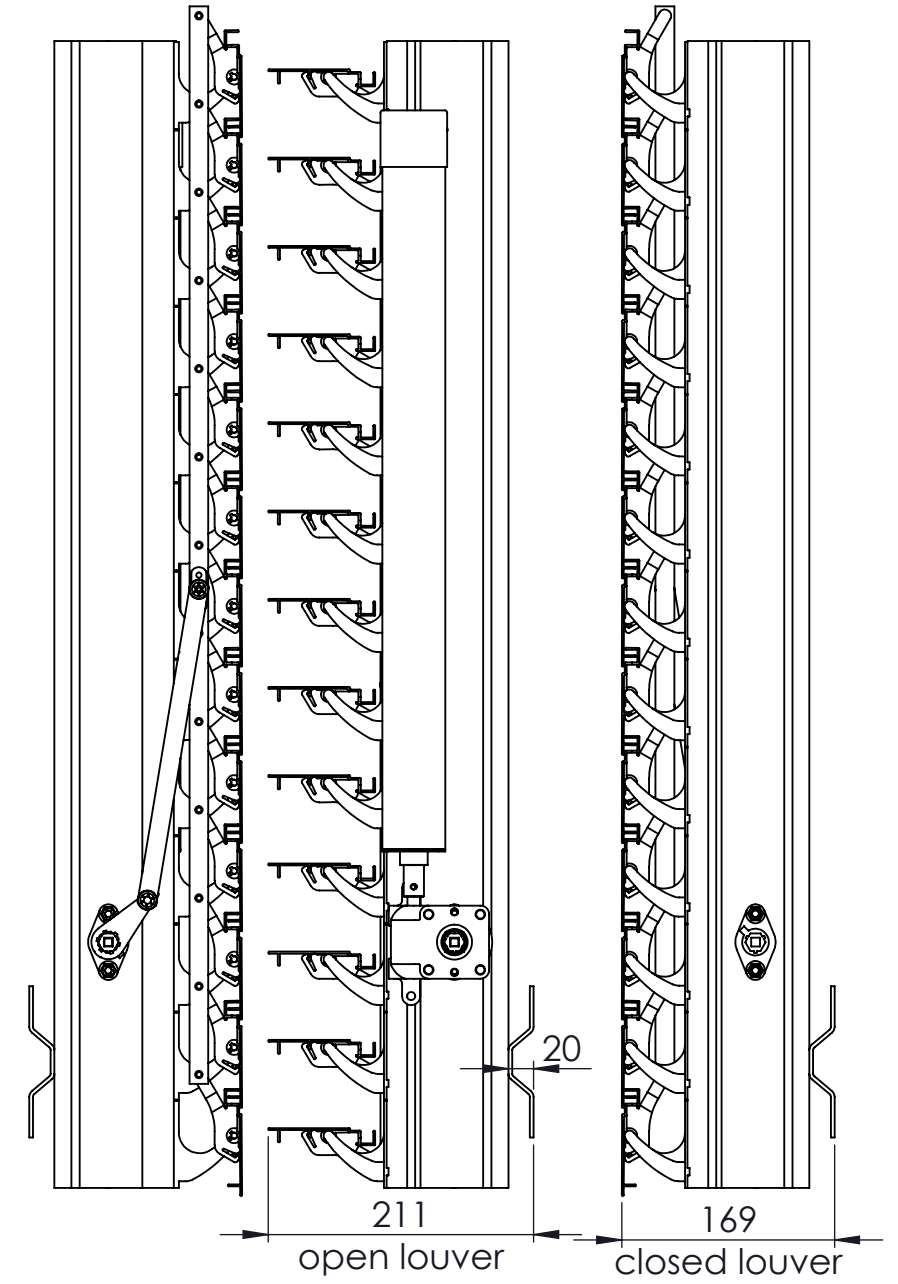

* Additional heavy duty Rack Arm extrusion options are available. Please contact Horiso for more information.

88E scale 1:6

horiso®

E: info@horiso.com.au | T: +61 2 8755 4500

horiso.com.au